

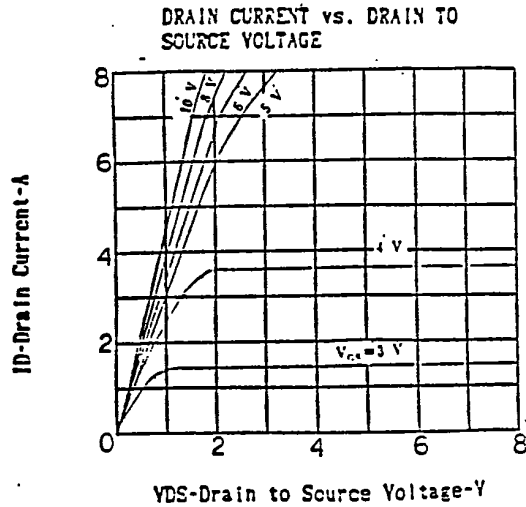

6427525 N E C ELECTRONICS INC  
TURN-ON AND TURN-OFF TIME TEST CIRCUIT

98D 18959 D T-39-07

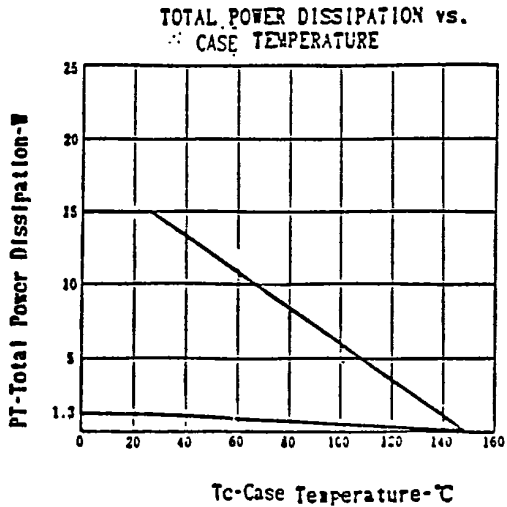

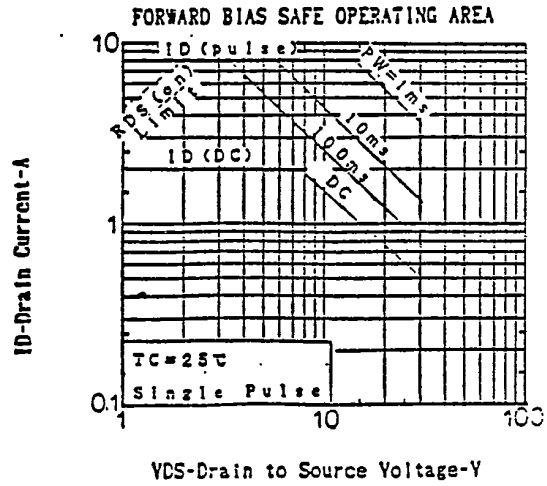
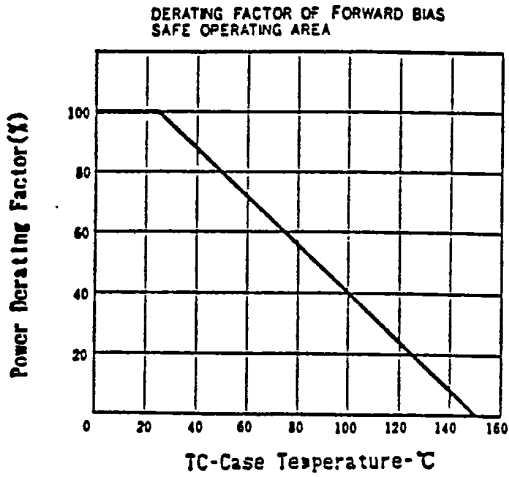
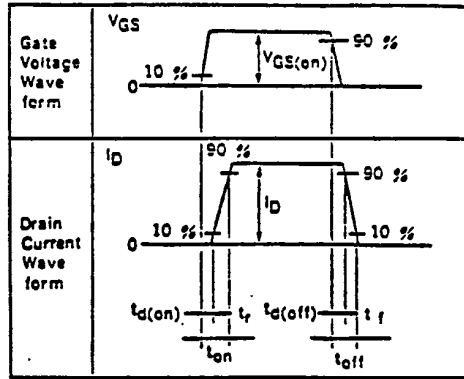
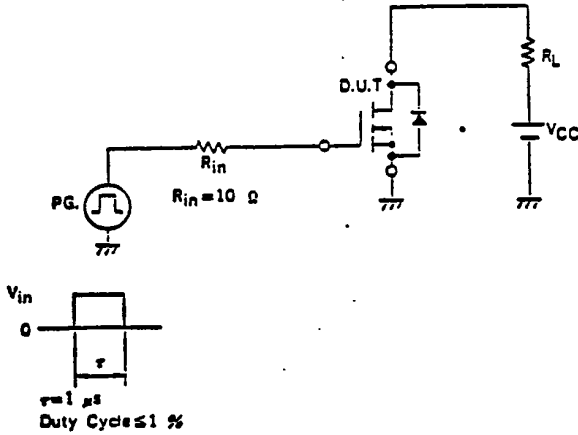
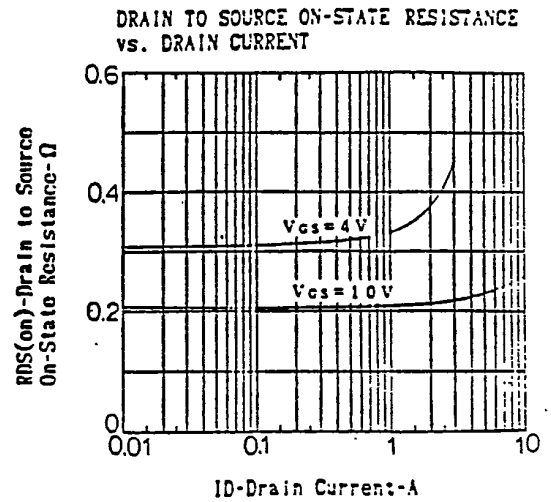
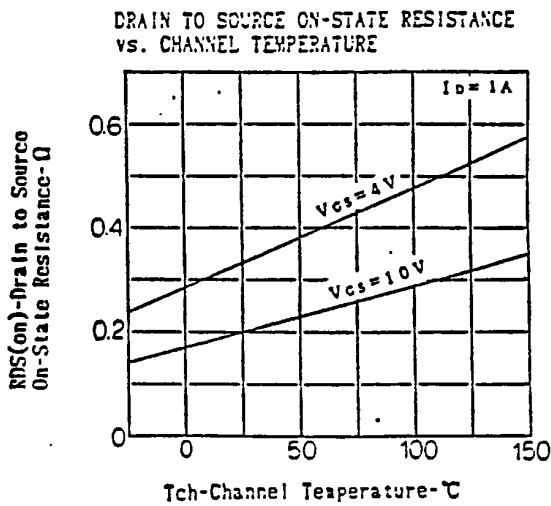
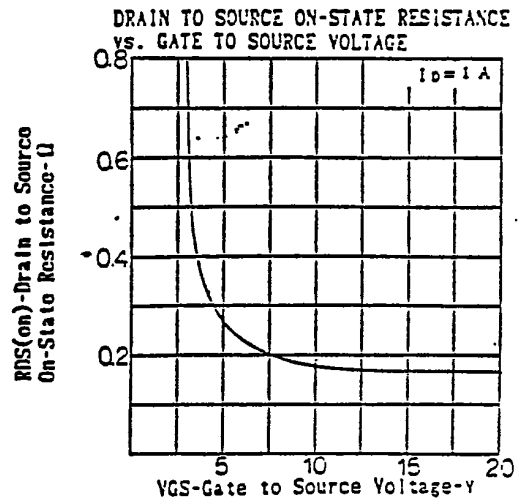
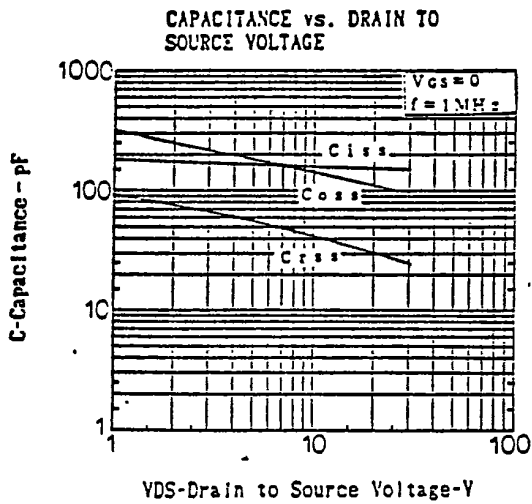
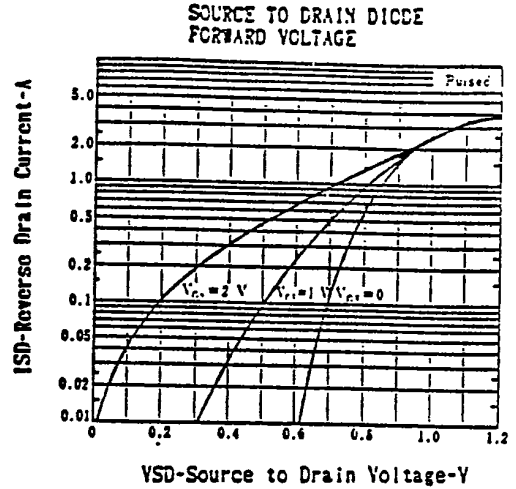
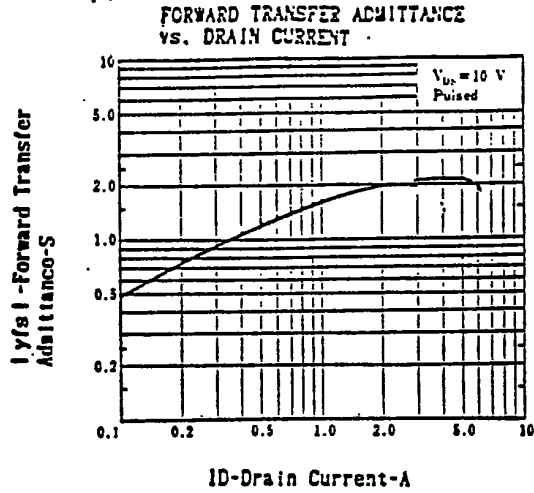

TRANSFER CHARACTERISTICS

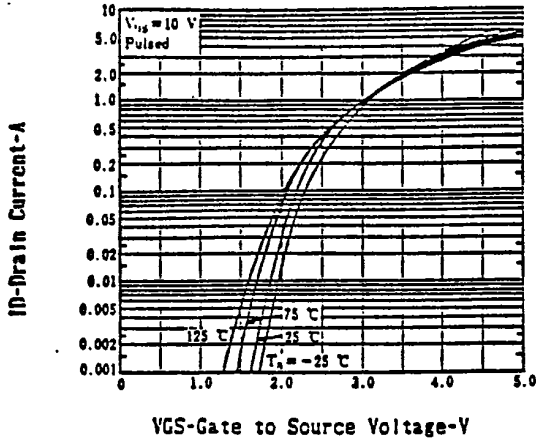

GATE TO SOURCE CUTOFF VOLTAGE vs. CHANNEL TEMPERATURE

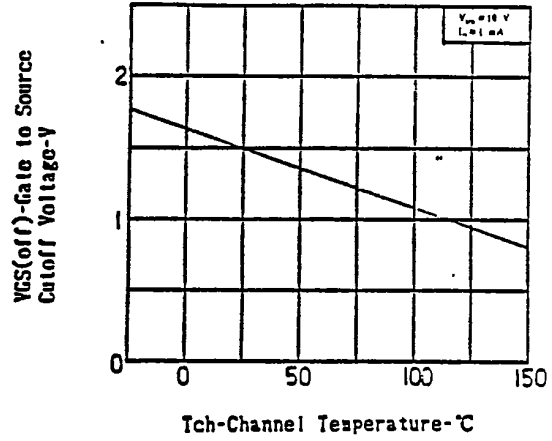

SWITCHING CHARACTERISTICS

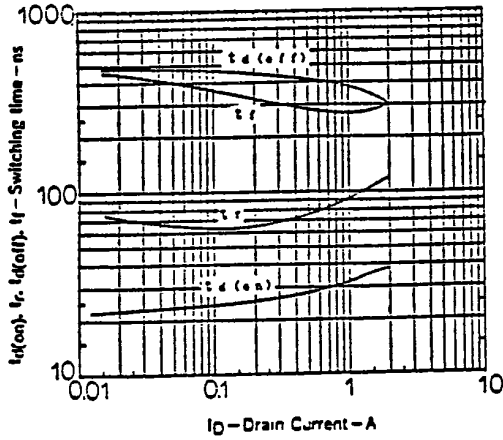

## NEC Corporation

INTERNATIONAL ELECTRON DEVICES DIV.  
 NEC Building, 33-1, Shiba Gocho  
 Minato-ku, Tokyo 108, Japan  
 Tel: Tokyo 454-1111  
 Telex Address: NECTOK J22686  
 Cable Address: MICROPHONE TOKYO

Printed in Japan